



INTERIOR DOORS

2026





UPA-I-202



UPA-I-201



www.upaarmoureddoors.com

UPA-I-203



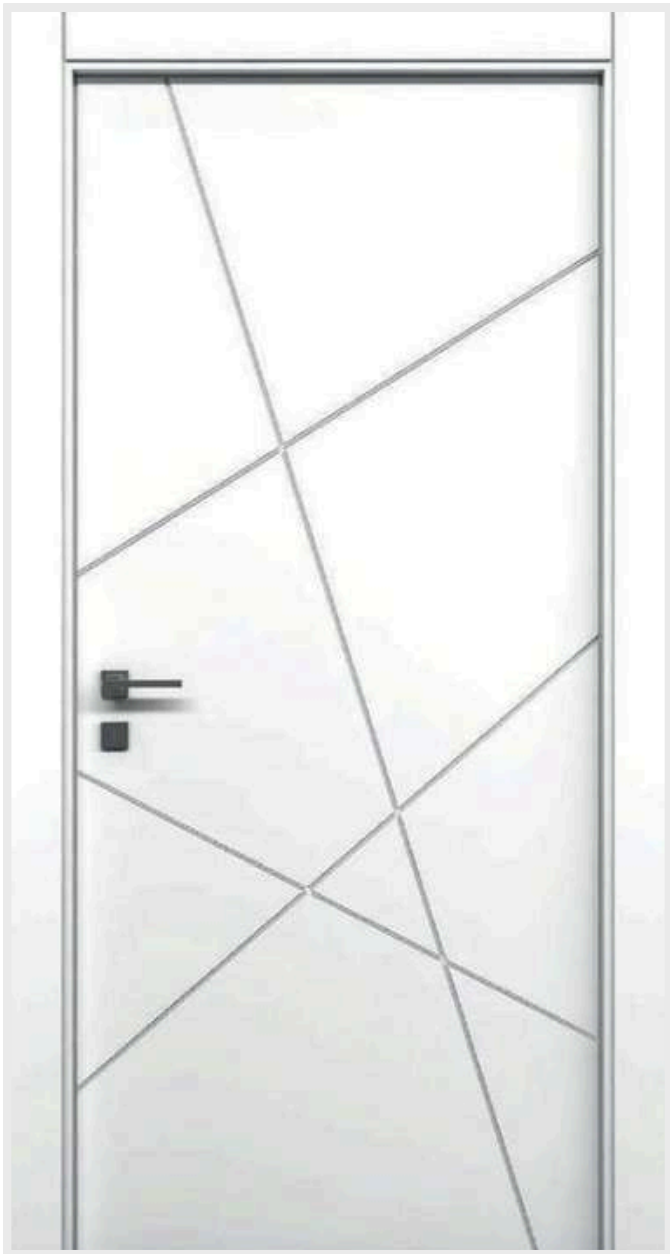

UPA-I-205



UPA-I-204



www.upaarmoureddoors.com

UPA-I-206





UPA-I-208



UPA-I-207



www.upaarmoureddoors.com

UPA-I-209





UPA-I-2011



UPA-I-2010



www.upaarmoureddoors.com

UPA-I-2012





UPA-I-2014



UPA-I-2013



www.upaarmoureddoors.com

UPA-I-2015



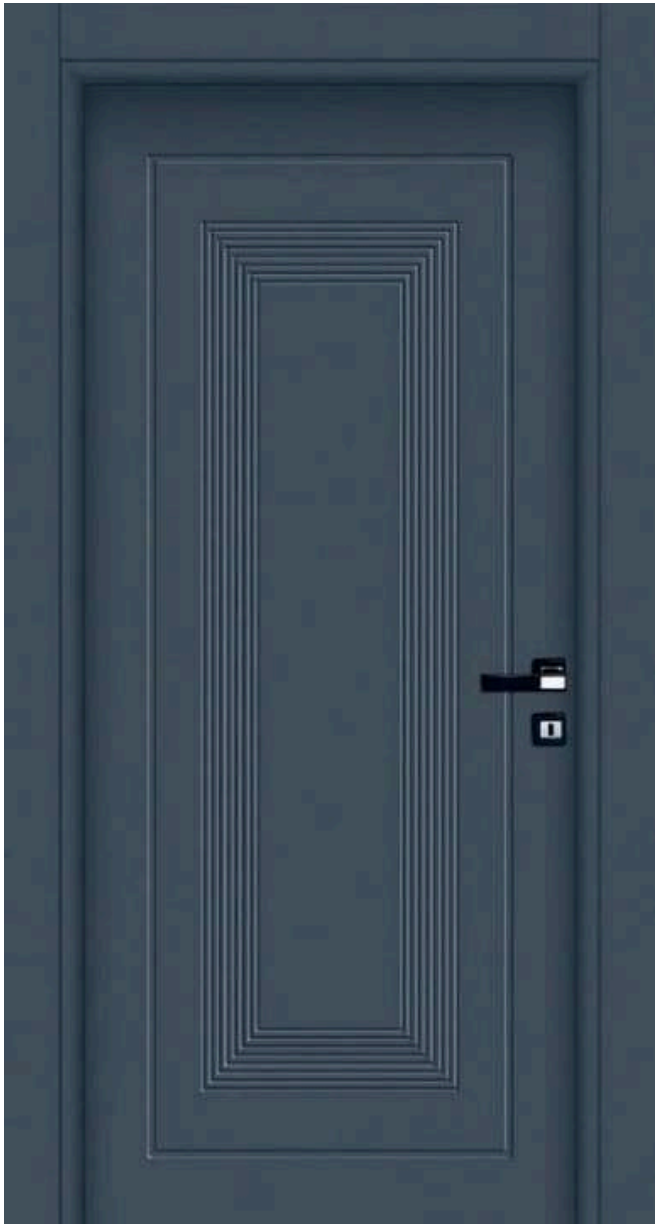

UPA-I-2017



UPA-I-2016



www.upaarmoureddoors.com

UPA-I-2018





UPA-I-2021



UPA-I-2020



www.upaarmoureddoors.com

UPA-I-2022





UPA-I-2024



UPA-I-2023



www.upaarmoureddoors.com

UPA-I-2025





UPA-I-2026



UPA-I-2025



www.upaarmoureddoors.com

UPA-I-2027





UPA-I-2029



UPA-I-2028



www.upaarmoureddoors.com

UPA-I-2030





UPA-I-2032



UPA-I-2031



www.upaarmoureddoors.com

UPA-I-2033





UPA-I-2035



UPA-I-2034



www.upaarmoureddoors.com

UPA-I-2036





UPA-I-2038



UPA-I-2037



www.upaarmoureddoors.com

UPA-I-2039





UPA-I-2041



UPA-I-2040



www.upaarmoureddoors.com

UPA-I-2042





UPA-I-2044



UPA-I-2043



www.upaarmoureddoors.com

UPA-I-2045





UPA-I-2047



UPA-I-2046



www.upaarmoureddoors.com

UPA-I-2048





UPA-I-2050



UPA-I-2049



www.upaarmoureddoors.com

UPA-I-2051





UPA-I-2053

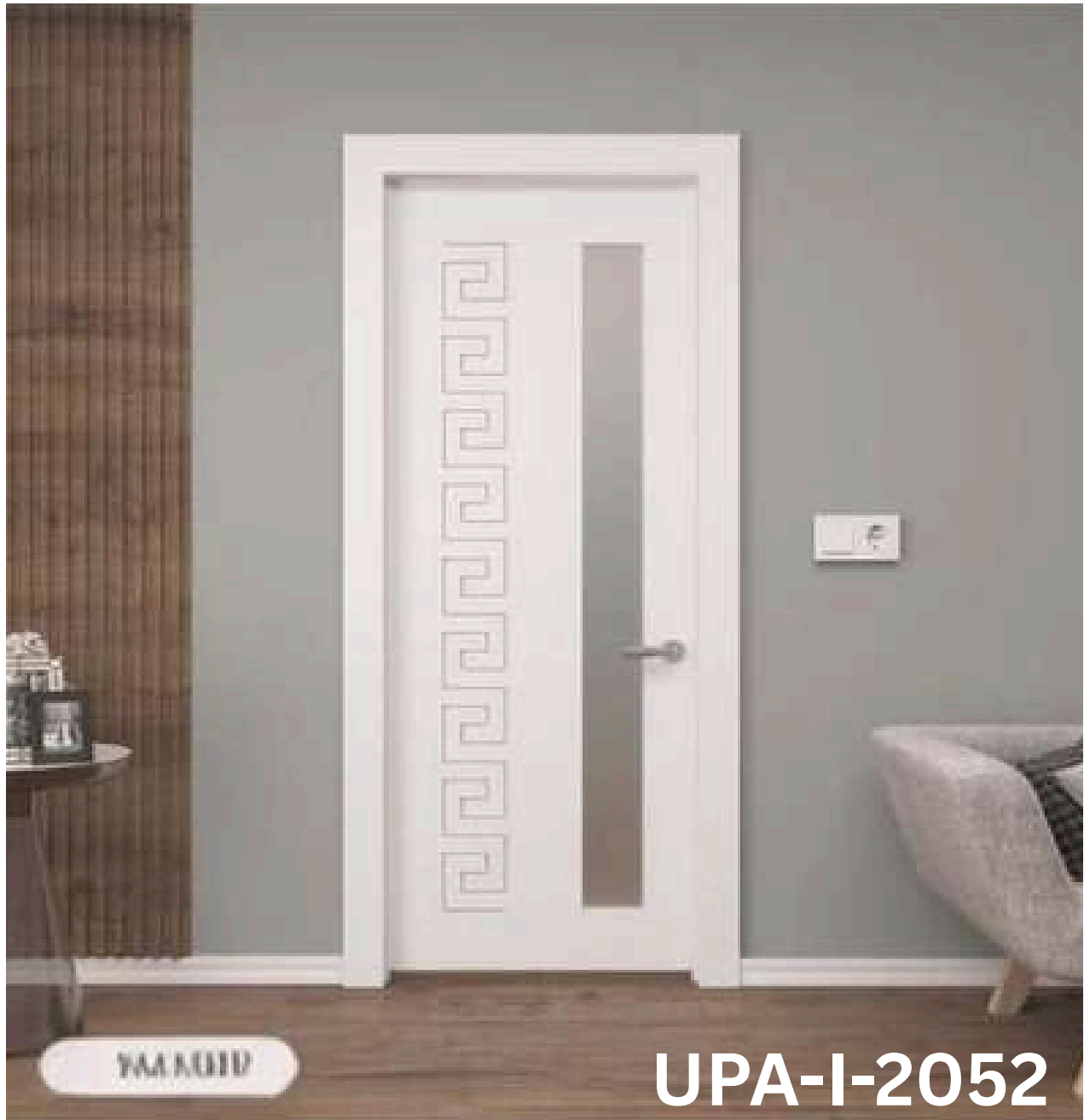

UPA-I-2052



www.upaarmoureddoors.com

UPA-I-2054





UPA-I-2056



UPA-I-2055



www.upaarmoureddoors.com

UPA-I-2057





UPA-I-2059



UPA-I-2058



www.upaarmoureddoors.com



UPA-I-2060



UPA-I-2062



UPA-I-2061



www.upaarmoureddoors.com

UPA-I-2063





UPA-I-2065



UPA-I-2064



www.upaarmoureddoors.com

UPA-I-2066



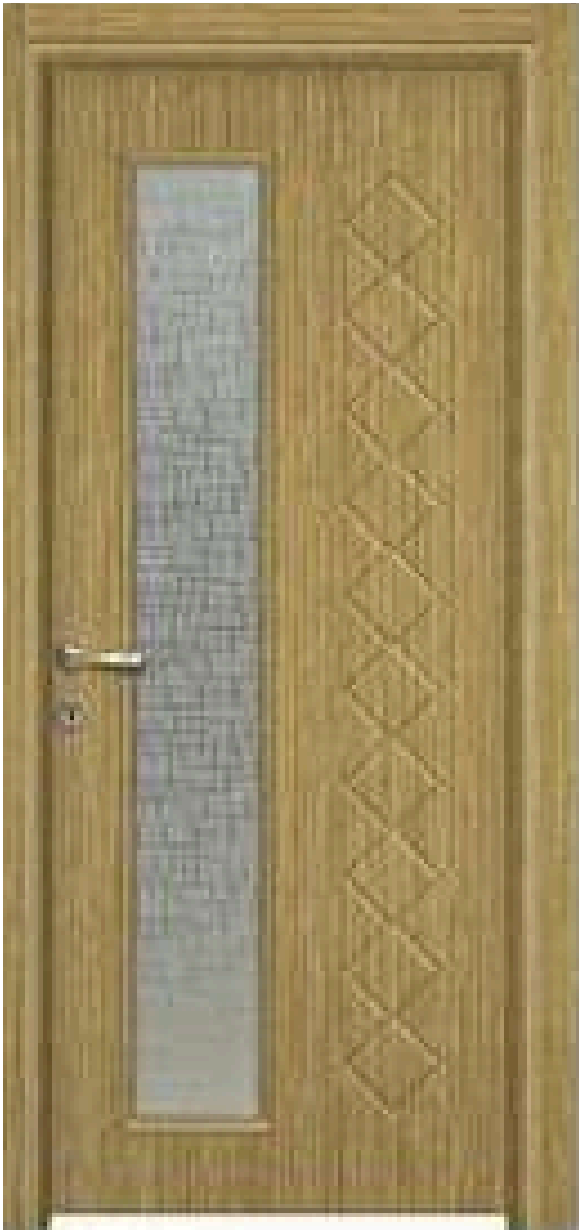

UPA-I-2068



UPA-I-2067



www.upaarmoureddoors.com

UPA-I-2069





UPA-I-2071



UPA-I-2070



www.upaarmoureddoors.com

UPA-I-2072





UPA-I-2074



UPA-I-2073



www.upaarmoureddoors.com

UPA-I-2075



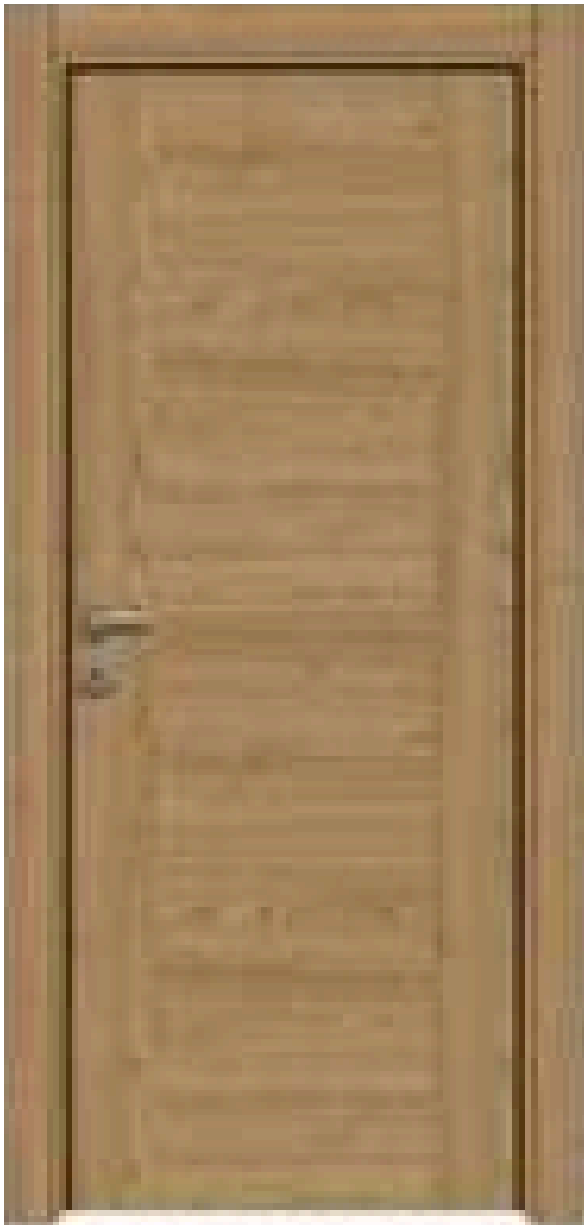

UPA-I-2077



UPA-I-2076



www.upaarmoureddoors.com

UPA-I-2078





UPA-I-2080



UPA-I-2079



www.upaarmoureddoors.com

UPA-I-2081





UPA-I-2083



UPA-I-2082



www.upaarmoureddoors.com

UPA-I-2084





UPA-I-2086



UPA-I-2085



www.upaarmoureddoors.com

UPA-I-2087

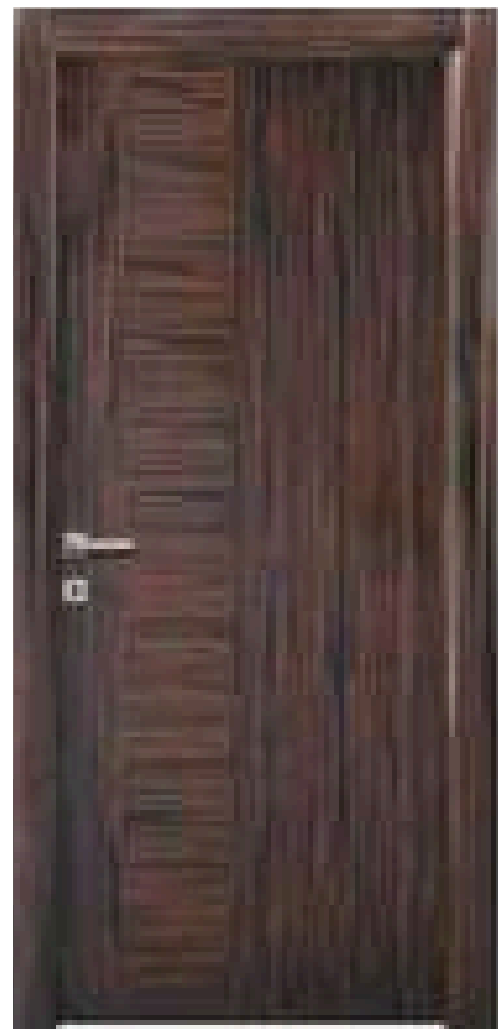



UPA-I-2089



UPA-I-2088



www.upaarmoureddoors.com

UPA-I-2090

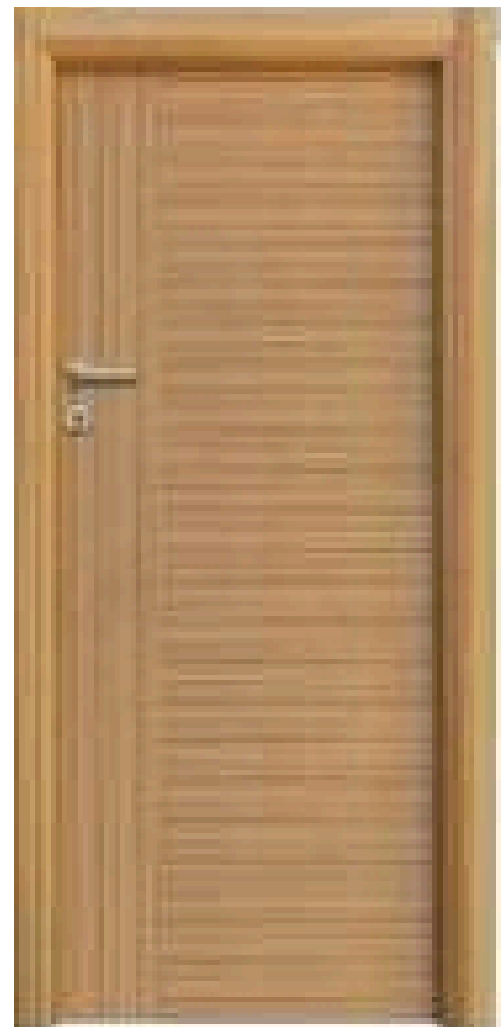



UPA-I-2092



UPA-I-2091



UPA-I-2094

UPA-I-2093





UPA-I-2096



UPA-I-2095

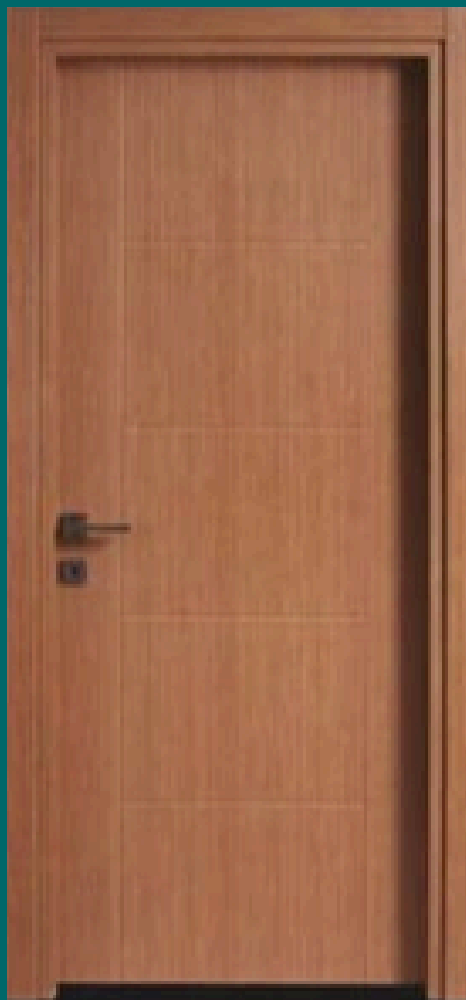

UPA-I-2098

UPA-I-2097





UPA-I-2099

UPA-I-2100



www.upaarmoureddoors.com

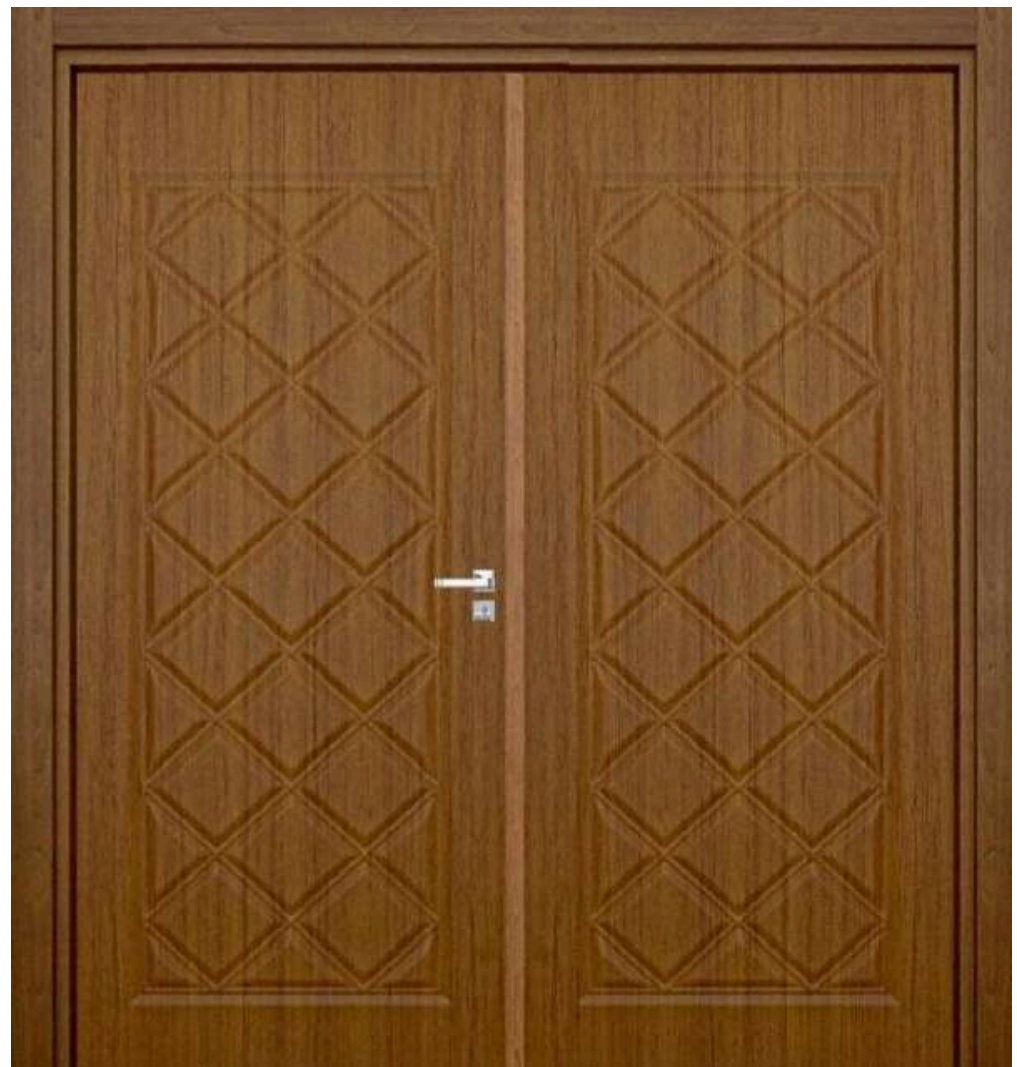

DOOR FEATURES

	LAQUER DOOR	PVC MEMBRANE DOOR	MELAMINE DOOR	COMPOSITE PANEL DOOR
WING MATERIA		4-6 mm MDF	4-6 mm MDF	4-6 mm MDF
SURFASE	Raw MDF surface is painted with 3 layers with advanced pint techniques.	Raw MDF surface is covered with 0.20 micron imported PVC material in different tools.	Selfpatterned and colored ready-made melamine surface.	Paints applied in the color emboide senlf-patterned panel surface.
MEASUREME NT	In desired dimensions	In desired dimensions	In desired dimensions	In desired dimensions
PULLEY FRAME	Wood Material	Wood Material	Wood Material	Wood Material
INNER FILLING	Wooden Grid or Kraft Paper Honeycomb	Wooden Grid or Kraft Paper Honeycomb	Wooden Grid or Kraft Paper Honeycomb	
FRAME AND SIDE	Paintable PP* coated MDF FrameandFrame PP coated Sandwich Case obtainedby placing kiln-dried wood between two 12 mmMDF Paintable PP Coated Composite Material	0.20 Micron PVC coated MDF FrameandFrame PP coated Sandwich Case obtained by placing kiln-dried wood between two 12 mmMDF 0.20 Micron PVC Coated Composite Material	Foil-covered MDF FrameandFrame Foil covered Sandwich Case obtainedby placing kiln-dried wood between two 12 mmMDF Foil Covered Composite Material	PVC



ALL DOORS' MODELS ARE AVAILABLE TO BE PRODUCED IN ALL DIFFERENT MATERIALS REGARDING CUSTOMERS REQUESTS!

PULLEY/DOOR LEAF FEATURES

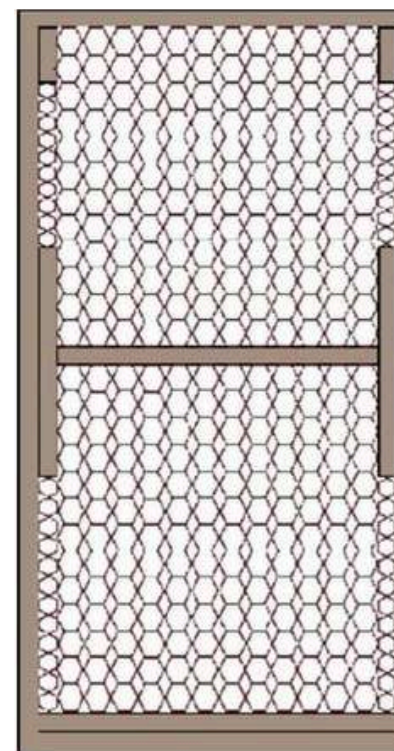
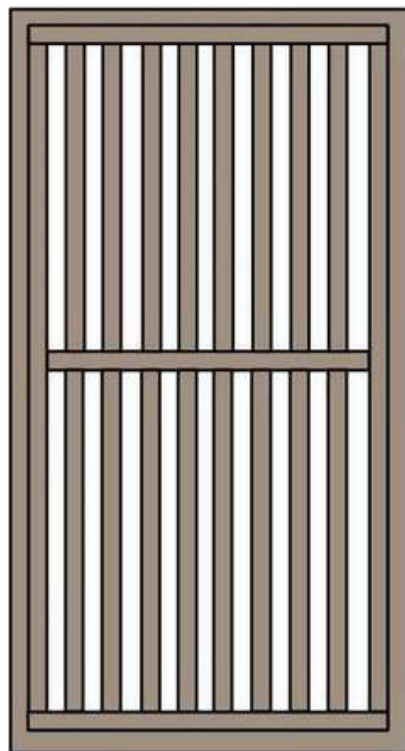

	WOOD GRILL HOLDER	KRAFT HONEYCOMB FILLED HOLE PVC MEMBRANE DOOR
FRAME	A pulley frame is made from baked fir, spruce, pine trees with 28-30-32 mm x 45 mm attachments prepared in a way that does not bend, or optionally imported slats.	A pulley frame is made from baked fir, spruce, pine trees with 28-30-32 mm x 45 mm attachments prepared in a way that does not bend, or optionally imported slats.
INNER MATERIAL	It is grided with an optional density from dried pine or fir wood, which is called as core.	The inside of the hoop is filled with this filling material, which is obtained by combining kraft or testliner type paper with a special technique and resembles a special technique and resembles a honeycomb in shape.
DIMENSIONS	28-30-32 mm Thickness + Desired width and length.	28-30-32 mm Thickness + Desired width and length



COMPOSITE DOOR FILLING

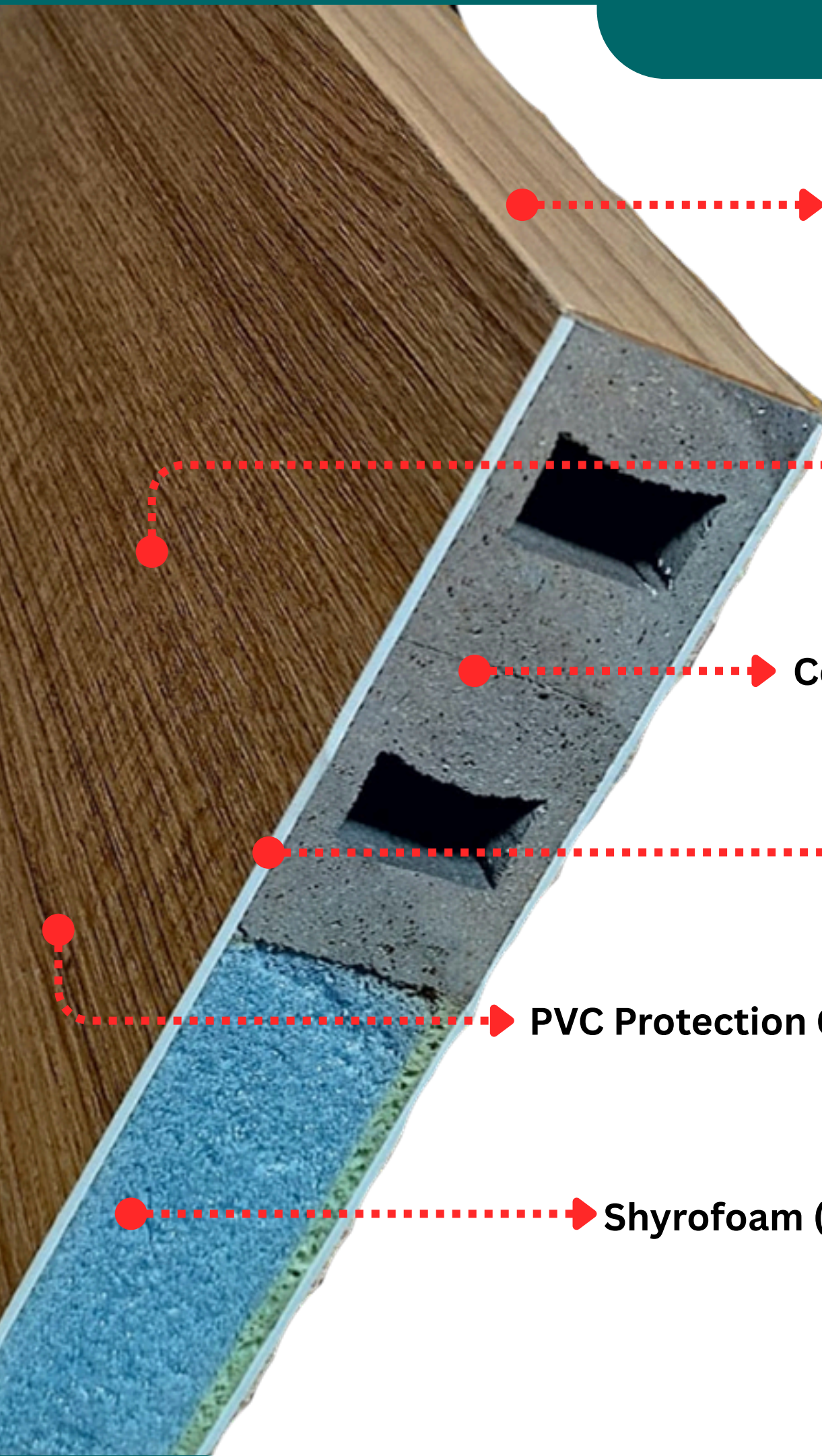

Edge Band 1mm

PVC Foil 0.20 mic

Composite Profiles 36x45 mm

PVC Thermoform Sheet 1.5 mm

PVC Protection Gelatinx

Shyrofoam (EPS & XPS) 36 mm



PULLEY/DOOR LEAF FEATURES



	MDF CASE	SANDWICH CASE	COMPOSITE CASE
THICKNESS	36-42mm	36-42 mm	36-42 mm
WIDTH	10-40 cm	10-40 cm	10-40 cm
LENGTH	In desired length	In desired length	In desired length
SURFACE APPLICATION	Paint (PP* WraPED) +PVC Coating	Paint (PP* WraPED) +PVC Coating	PVC



	MDF STRING	COMPOSITE STRING
WIDTH	8-27 cm	4-10 cm
LENGTH	In desired length	In desired length
SURFACE	Paint (PP* WraPED) +PVC Coating	PVC

PP* - Printable Paper is a protective material used to make the paint more permanent and to make the wood longer lasting. The surface is first covered with PP and then paint applied.



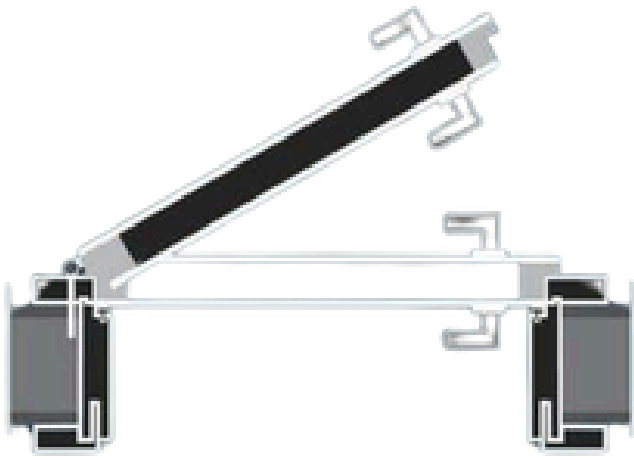

Door opens to the Left

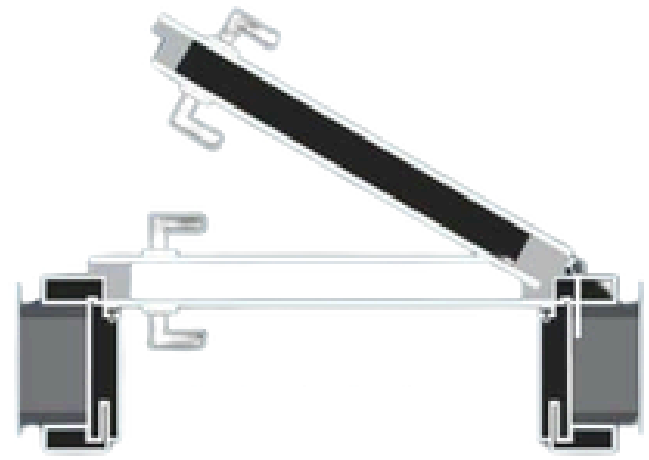

Door opens to the Right

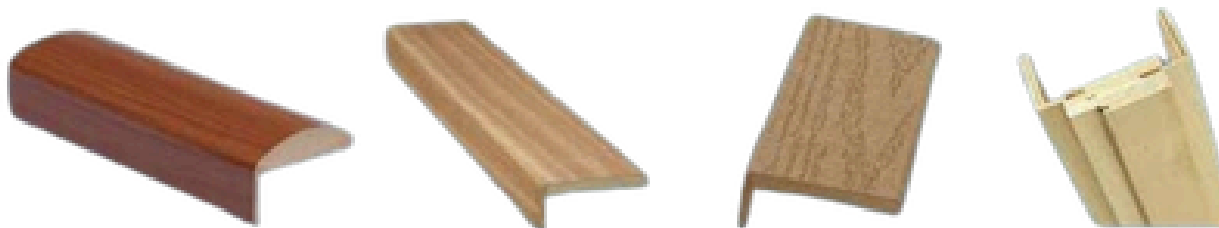
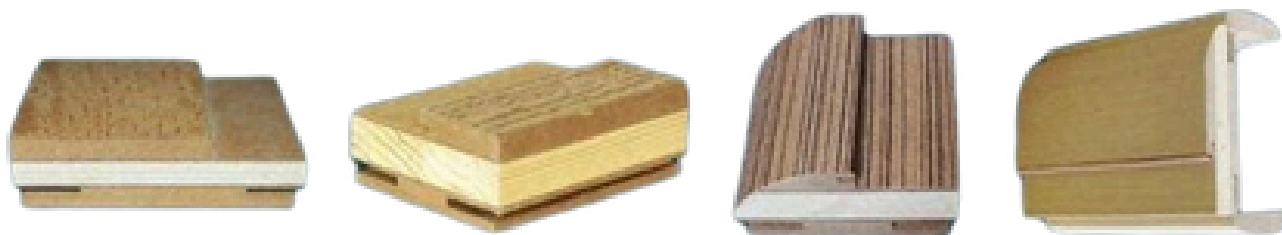

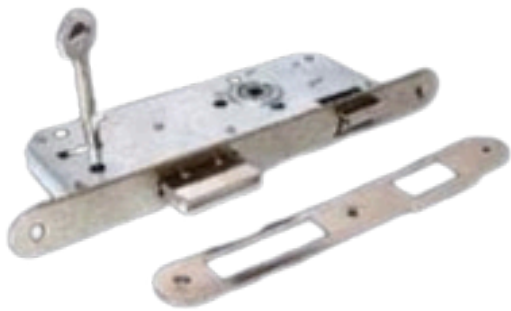

CERTIFICATION

MILCERT

UPA ARMOURED DOORS
UPA DANIŞMANLIK İTHALAT VE İHRACAT
LIMITED ŞİRKETİ

PIRI REİS MAH. 1993. SK. PAPAĞYIA 3 NO. 23 İÇ KAPI NO: 101
ESENÜYRÜT/İSTANBUL

Kuruluşun "UZMANLAŞMAMIŞ TOPTAN TİCARİT İLE İLGİLİ
ARACILARIN FAALİYETLERİ" Kapsamı İçin

For scope "ACTIVITIES OF INTERMEDIARIES RELATED TO NON-
SPECIALIZED WHOLESALE TRADE"

KALİTE YÖNETİM SİSTEMİ
QUALITY MANAGEMENT SYSTEM

ISO 9001:2015

Sertifika Numarası/Certificate Number :A13442
Sertifika Kodu / Certificate Code :UPA DANIŞMANLIK
Sertifika Yayın Tarihi / Certificate Issue Date :30.05.2025
Sertifika Geçerlilik Tarihi/Certificate Validity Date :30.05.2028
Sertifika Periyodu/ Certificate Period :1Yıl / 1 Year

YAS ACCREDITED **100%** **MILCERT**

MILCERT ULUSLARARASI BELGELENDİRME ŞİRKETİ
Cumhuriyet Mah. E-6 Karapınar Fıstık Sokak İstanbul Outer Park, K:2 D:04 Beşiktaş/İstanbul
Telefon: 0850 840 34 12 - E-mail: info@milcertification.com

CERTIFICATION

MILCERT

UPA ARMOURED DOORS
UPA DANIŞMANLIK İTHALAT VE İHRACAT
LIMITED ŞİRKETİ

PIRI REİS MAH. 1993. SK. PAPAĞYIA 3 NO. 23 İÇ KAPI NO: 101
ESENÜYRÜT/İSTANBUL

Kuruluşun "UZMANLAŞMAMIŞ TOPTAN TİCARİT İLE İLGİLİ
ARACILARIN FAALİYETLERİ" Kapsamı İçin

For scope "ACTIVITIES OF INTERMEDIARIES RELATED TO NON-
SPECIALIZED WHOLESALE TRADE"

ÇEVRE YÖNETİM SİSTEMİ
ENVIRONMENTAL MANAGEMENT SYSTEM

ISO 14001:2015

Sertifika Numarası/Certificate Number :A13444
Sertifika Kodu / Certificate Code :UPA DANIŞMANLIK
Sertifika Yayın Tarihi / Certificate Issue Date :30.05.2025
Sertifika Geçerlilik Tarihi/Certificate Validity Date :30.05.2028
Sertifika Periyodu/ Certificate Period :1Yıl / 1 Year

YAS ACCREDITED **100%** **MILCERT**

MILCERT ULUSLARARASI BELGELENDİRME ŞİRKETİ
Cumhuriyet Mah. E-6 Karapınar Fıstık Sokak İstanbul Outer Park, K:2 D:04 Beşiktaş/İstanbul
Telefon: 0850 840 34 12 - E-mail: info@milcertification.com

CERTIFICATION

MILCERT

UPA ARMOURED DOORS
UPA DANIŞMANLIK İTHALAT VE İHRACAT
LIMITED ŞİRKETİ

PIRI REİS MAH. 1993. SK. PAPAĞYIA 3 NO. 23 İÇ KAPI NO: 101
ESENÜYRÜT/İSTANBUL

Kuruluşun "UZMANLAŞMAMIŞ TOPTAN TİCARİT İLE İLGİLİ
ARACILARIN FAALİYETLERİ" Kapsamı İçin

For scope "ACTIVITIES OF INTERMEDIARIES RELATED TO NON-
SPECIALIZED WHOLESALE TRADE"

İŞ SAĞLIĞI VE GÜVENLİĞİ YÖNETİM SİSTEMİ
OCCUPATIONAL HEALTH AND SAFETY MANAGEMENT SYSTEM

ISO 45001:2018

Sertifika Numarası/Certificate Number :A13447
Sertifika Kodu / Certificate Code :UPA DANIŞMANLIK
Sertifika Yayın Tarihi / Certificate Issue Date :30.05.2025
Sertifika Geçerlilik Tarihi/Certificate Validity Date :30.05.2028
Sertifika Periyodu/ Certificate Period :1Yıl / 1 Year

YAS ACCREDITED **100%** **MILCERT**

MILCERT ULUSLARARASI BELGELENDİRME ŞİRKETİ
Cumhuriyet Mah. E-6 Karapınar Fıstık Sokak İstanbul Outer Park, K:2 D:04 Beşiktaş/İstanbul
Telefon: 0850 840 34 12 - E-mail: info@milcertification.com

CERTIFICATION

MILCERT

UPA ARMOURED DOORS
UPA DANIŞMANLIK İTHALAT VE İHRACAT
LIMITED ŞİRKETİ

PIRI REİS MAH. 1993. SK. PAPAĞYIA 3 NO. 23 İÇ KAPI NO: 101
ESENÜYRÜT/İSTANBUL

MÜŞTERİ MEMNUNİYETİ VE ŞİKAYETLERİ YÖNETİM SİSTEMİ
CUSTOMER SATISFACTION AND COMPLAINTS MANAGEMENT SYSTEM

ISO 10002 :2018

Sertifika Numarası/Certificate Number :A13443
Sertifika Kodu / Certificate Code :UPA DANIŞMANLIK
Sertifika Yayın Tarihi / Certificate Issue Date :30.05.2025
Sertifika Geçerlilik Tarihi/Certificate Validity Date :30.05.2028
Sertifika Periyodu/ Certificate Period :1Yıl / 1 Year

YAS ACCREDITED **100%** **MILCERT**

MILCERT ULUSLARARASI BELGELENDİRME ŞİRKETİ
Cumhuriyet Mah. E-6 Karapınar Fıstık Sokak İstanbul Outer Park, K:2 D:04 Beşiktaş/İstanbul
Telefon: 0850 840 34 12 - E-mail: info@milcertification.com

CERTIFICATION

MILCERT

UPA ARMOURED DOORS
UPA DANIŞMANLIK İTHALAT VE İHRACAT
LIMITED ŞİRKETİ

PIRI REİS MAH. 1993. SK. PAPAĞYIA 3 NO. 23 İÇ KAPI NO: 101
ESENÜYRÜT/İSTANBUL

Kuruluşun "UZMANLAŞMAMIŞ TOPTAN TİCARİT İLE İLGİLİ
ARACILARIN FAALİYETLERİ" Kapsamı İçin

For scope "ACTIVITIES OF INTERMEDIARIES RELATED TO NON-
SPECIALIZED WHOLESALE TRADE"

SOSYAL SORUMLULUK YÖNETİM SİSTEMİ
SOCIAL RESPONSIBILITY MANAGEMENT SYSTEM

ISO 26000:2010

Sertifika Numarası/Certificate Number :A13445
Sertifika Kodu / Certificate Code :UPA DANIŞMANLIK
Sertifika Yayın Tarihi / Certificate Issue Date :30.05.2025
Sertifika Geçerlilik Tarihi/Certificate Validity Date :30.05.2028
Sertifika Periyodu/ Certificate Period :1Yıl / 1 Year

YAS ACCREDITED **100%** **MILCERT**

MILCERT ULUSLARARASI BELGELENDİRME ŞİRKETİ
Cumhuriyet Mah. E-6 Karapınar Fıstık Sokak İstanbul Outer Park, K:2 D:04 Beşiktaş/İstanbul
Telefon: 0850 840 34 12 - E-mail: info@milcertification.com

CERTIFICATION

MILCERT

UPA ARMOURED DOORS
UPA DANIŞMANLIK İTHALAT VE İHRACAT
LIMITED ŞİRKETİ

PIRI REİS MAH. 1993. SK. PAPAĞYIA 3 NO. 23 İÇ KAPI NO: 101
ESENÜYRÜT/İSTANBUL

Kuruluşun "UZMANLAŞMAMIŞ TOPTAN TİCARİT İLE İLGİLİ
ARACILARIN FAALİYETLERİ" Kapsamı İçin

For scope "ACTIVITIES OF INTERMEDIARIES RELATED TO NON-
SPECIALIZED WHOLESALE TRADE"

ISO 31000:2018
KURUMSAL RİSK YÖNETİM SİSTEMİ
RISK MANAGEMENT SYSTEM

Sertifika Numarası/Certificate Number :A13446
Sertifika Kodu / Certificate Code :UPA DANIŞMANLIK
Sertifika Yayın Tarihi / Certificate Issue Date :30.05.2025
Sertifika Geçerlilik Tarihi/Certificate Validity Date :30.05.2028
Sertifika Periyodu/ Certificate Period :1Yıl / 1 Year

YAS ACCREDITED **100%** **MILCERT**

MILCERT ULUSLARARASI BELGELENDİRME ŞİRKETİ
Cumhuriyet Mah. E-6 Karapınar Fıstık Sokak İstanbul Outer Park, K:2 D:04 Beşiktaş/İstanbul
Telefon: 0850 840 34 12 - E-mail: info@milcertification.com

CERTIFICATION

MILCERT

CE UYGUNLUK BEYANI
CE DECLARATION OF CONFORMITY
UPA ARMOURED DOORS
UPA DANIŞMANLIK İTHALAT VE İHRACAT
LIMITED ŞİRKETİ

PIRI REİS MAH. 1993. SK. PAPAĞYIA 3 NO. 23 İÇ KAPI NO: 101
ESENÜYRÜT/İSTANBUL

We declare that the declared version of the product, as described below, complies with the
design and type specifications determined by us, and meets the essential safety and health
requirements in accordance with (EU/2002/95) General Product Safety Regulation and
"In the event of any modifications to the product, this declaration will become invalid unless
mutually agreed upon by us

Tuzlin edilen versiyonlarımızın, aşağıda tanımlanan ürünün, (EU/2002/95) Genel Ürün
Güvenliği Yönetmeliği'ne uygun olduğunu, tasarımı ve ilgili zarfına yazılan esas teknik özellikleri
ve esaslı parçalarına uygun olduğuna beyan ederiz. Örnekte herhangi bir değişikliğe uygulanmış
durumunda, zarfımıza üzerinde değişiklik kalemlenmiş bu beyan geçerliliğini yitirecektir.

Description Of the Product / Product Part :STEEL DOOR
Orjinal / Orjin Parça Tanımı :ÇELİK KAPI

Uygulanabilir Direktifler/ Applicable EC Directives :EU/2002/95
Uygulanabilir Standartlar/ Applicable Harmonized Standards :TS EN ISO 9140-2/TS 12665/TS EN 1827
TS EN 1830/EN 1204 / EN 12287, EN 1191

Sertifika Kodu / Certificate Code :UPA DANIŞMANLIK
Sertifika Numarası / Certificate Number :A13441
Sertifika Yayın Tarihi / Certificate Issue Date :30.05.2025
Sertifika Geçerlilik Tarihi / Certificate Validity Date :30.05.2028
Sertifika Periyodu / Certificate Period :1 Yıl / 1 Year

YAS ACCREDITED **100%** **MILCERT**

MILCERT ULUSLARARASI BELGELENDİRME ŞİRKETİ
Cumhuriyet Mah. E-6 Karapınar Fıstık Sokak İstanbul Outer Park, K:2 D:04 Beşiktaş/İstanbul
Telefon: 0850 840 34 12 - E-mail: info@milcertification.com

TURK PATENT
MARKA TESCİL BELGESİ
No: 2025 079632 - Ticaret - Hizmet

UPA
ARMOURED DOORS

Marka Sahibi
UPA DANIŞMANLIK İTHALAT VE İHRACAT LIMITED ŞİRKETİ

Mal / Hizmet Sınıfları
06

Bu marka, 6769 sayılı Sınai Mülkiyet Kanunu kapsamında,
23.06.2025 tarihinden itibaren 10 yıl süreyle korunmak üzere,
05.12.2025 tarihinde tescil edilmiştir.

Prof. Dr. M. Zeki DURAK
Başkan





○
MAKE YOUR
HOME SAFER
WITH
OUR DOORS

FACTORY / TÜRKİYE
IBRAHİM KUMANI

CONTACT: 00905428261455
E-mail: info@upaarmoureddoors.com
ADDRESS: Piri Reis Mah. 1993. Sk.
No: 23 İç Kapı No: 101,
Papatya 3 Residans
ESENYURT/İSTANBUL



SHOWROOM-DISTRIBUTOR / USA
JENNY FERNANDA DUARTE

CONTACT: +1 (310) 461-6075
E-mail: info@upaarmoureddoors.com
ADDRESS: 2828 Butler Ave Lynwood,
CA 90262

www.upaarmoureddoors.com